

UNITED STATES
DEPARTMENT OF THE INTERIOR

EMERGENCY CONSERVATION WORK
PROJECT TRAINING

BRICK AND STONE WORK



P. T. SERIES NO. 5

UNITED STATES
DEPARTMENT OF THE INTERIOR

Washington

Emergency Conservation Work
Project Training

BRICK AND STONE WORK

The material in this text, which may be used both for training on the project and as the foundation for a course in the camp educational program, is selected from several sources for a short practical presentation of the subject.

Acknowledgment is made to The Common Brick Manufacturers' Association of America, and to the Portland Cement Association for permission to use information from their various publications; information which makes up much of the text here compiled. Other portions have been taken from the "Engineer Training Manual, Masonry, Appendix No. 5," of the United States Army.

No attempt is made to show how to use tools, as this can be done more satisfactorily in training on the project. The text is restricted to information which is essential to laying brick and stone in accordance with accepted practice.

TABLE OF CONTENTS

Bond	7
Cold Weather Protection	5
Glossary	22
Joints	7
Masonry, General	5
Materials Required for 100 square feet of Wall	27
Mortar, Materials	1
Mortar, Proportions	3
Steps and Walks of Brick	17
Stone Setting Rules	13
Types of Masonry	9
Veneers	13

BRICK AND STONE WORK

Definitions. A glossary of definitions and terms will be found at the end of this text.

Mortar. The business of mortar is to bind bricks and stones together to make a solid wall; to keep moisture out; to take up inequalities in the units; and to distribute the load on the wall. When good bricks or stones are laid in good mortar, with all joints filled, the wall will stand.

Sand. This is the base of all mortars, and it carries the load. It should be clean, hard, durable particles well graded from fine to coarse; all passing a 1/4 inch screen. Limestone screenings or crushed cinders can be used in place of sand for ordinary work, provided they are clean.

To hold the sand together in the joint, it must be mixed with a paste or putty made of lime, cement, or lime and cement together. The best mortar will contain a little more than enough putty to fill all the spaces between the grains of sand.

Lime. When lime comes from the kiln it is in lump form and is marketed in 180 pound barrels. It must be slaked before using, which means that it must be put into a pit or box and fed with water until it will take no more, but observing any rules the manufacturer may recommend. The longer it cures in the pit or box the better it will be for mortar or plaster. Lump lime is a fire hazard in storage. See that it is kept dry.

Hydrated lime is lump lime which has been slaked with precisely the right amount of water to leave it in powdered form. It comes in 50 pound sacks (40 pound sacks in a few states). It is not dangerous in storage or in use. It should be made into a thick paste or putty on the job.

Lump lime is cheaper than hydrated lime, and is preferred by many masons for that reason.

Caution. Burns from slaking lime may be serious. Wear Goggles! Sweet oil is the best thing to apply to a lime burn after it has been washed repeatedly with water. If a particle of hot lime should get into the eye, hold the lids open and let a drop of sweet oil fall directly on the eyeball. Do this immediately!

BRIDGES



Arbuckle Mountains. Oklahoma



Cook County Forest Preserve District, Illinois

Portland Cement. When cement is used it is added to lime mortar already made. Cement and sand alone make a harsh mortar, working with difficulty under the trowel, and lime is added to make it more plastic. Lime and cement together make the strongest mortar, and should always be used to carry heavy loads. Cement is preferable to lime for damp places, where lime will not set.

Substituting Lime for Cement. Lime cannot be substituted for cement where strength must be considered. Every lime-cement mortar is a compromise. On one side are the strength, harshness, dull color, water-tightness, and shrinkage in the cement; on the other are the plasticity, cheapness, whiteness, and weakness of the lime. They are combined to make the best mortar for each individual job.

Proportions. The proportions of lime, or lime-and-cement, to sand, must be determined by specifications or by trial. When the mixture has been worked out, to give maximum strength with workability, the proportions must be maintained throughout the job. Some masons can tell by the "feel" when the proportions are right. Without this knack it is better to measure every batch.

Straight Lime Mortar. For average work, one story walls and other jobs where strength is not important, and work above grade not exposed to moisture, and for non-porous units like glass brick. The peculiar quality of lime mortar is that it sticks; that is, it is adhesive. Cement lacks that quality. But straight lime mortar is not often used, because of the gain in initial setting and in strength by adding cement.

For good results use:

- 1 Cubic foot of lime paste or putty, and
- 3 Cubic feet of sand.

Lime-Cement Mortar: For work above grade, not exposed to dampness, where strength is a consideration. This has come into very general use, and is acceptable on all work which does not require a cement mortar. Mix as follows:

- 1 Cubic foot of lime paste or putty
- 1 Cubic foot (1 sack), of Portland cement
- 6 Cubic feet of sand

Cement Mortar: For work exposed to dampness, and work in which the major consideration is strength, mix as follows:

- 1 Cubic foot (1 sack), of Portland cement
- 1/10 Cubic foot of lime paste or putty
- 3 Cubic feet of sand.

BRIDGES



Honey Creek Parkway, Wisconsin



Wintersmith Municipal Park, Oklahoma



Lake Murray State Park, Oklahoma

Lime Putty. It is the practice in some places to slake lump lime into putty, and allow it to cure until needed. Sometimes it is slaked in time to allow months of curing, because the longer it cures the more plastic it becomes. In other sections the putty is immediately "cut" with about half the sand required, and then stacked for curing. With either of these methods, the cement cannot be added until required by the masons.

Mixing. In a mechanical mixer the dry ingredients are first mixed thoroughly, then the lime putty is added, followed by enough water to give the required consistency. If cement is used it is best to add it last, though it is often added with the dry sand and mixed with it before the lime putty is added.

For hand mixing, using lime putty, spread the sand out in the mortar box, work in the lime putty, more water, and last the cement. If a sanded putty is used, spread out only the additional sand needed, and proceed as for lime putty.

Time to Use. Straight lime mortar can stand any length of time if it is not allowed to dry out. Mortar containing cement must be used within one hour after the cement is added.

MASONRY

Masonry is the art of arranging and bedding building units in mortar, to form a solid mass with sufficient strength to carry the imposed load. Building units are clay, cement, or glass bricks and blocks, clay and concrete tile, and stone. Units are bedded in mortar, first, to distribute the pressure evenly throughout the wall, second, to bind the units together, and third, to make the wall weatherproof by filling the joints.

All building units should be wet down before being laid, especially in warm weather. Wetting removes dust which would keep mortar from sticking, and it fills the pores of the units so they do not draw too much moisture from the mortar. To draw the moisture from the mortar "kills" it. It cannot set.

PROTECTION IN COLD WEATHER

Low temperatures retard the setting of mortar, and freezing will kill "green" mortar. Portions of the work which have been frozen, or portions where the wall has been laid up faster than the slowly setting mortar can support the load, must be rebuilt. When the temperature drops below 40 degrees the sand and water must be heated, and the masonry must be protected immediately after laying to prevent the mortar from getting chilled.

EXTERIORS



Bastrop-Buescher State Park, Texas

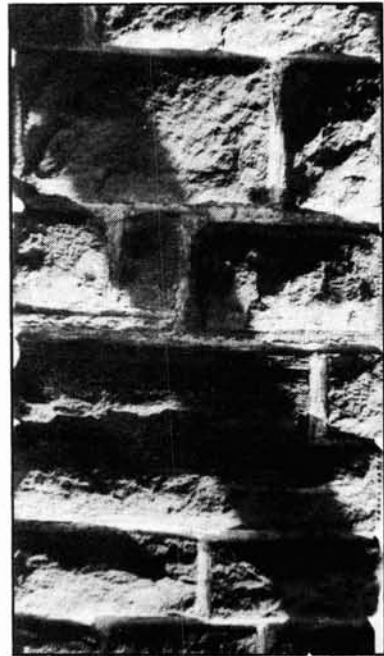

Bastrop-Buescher State Park, Texas

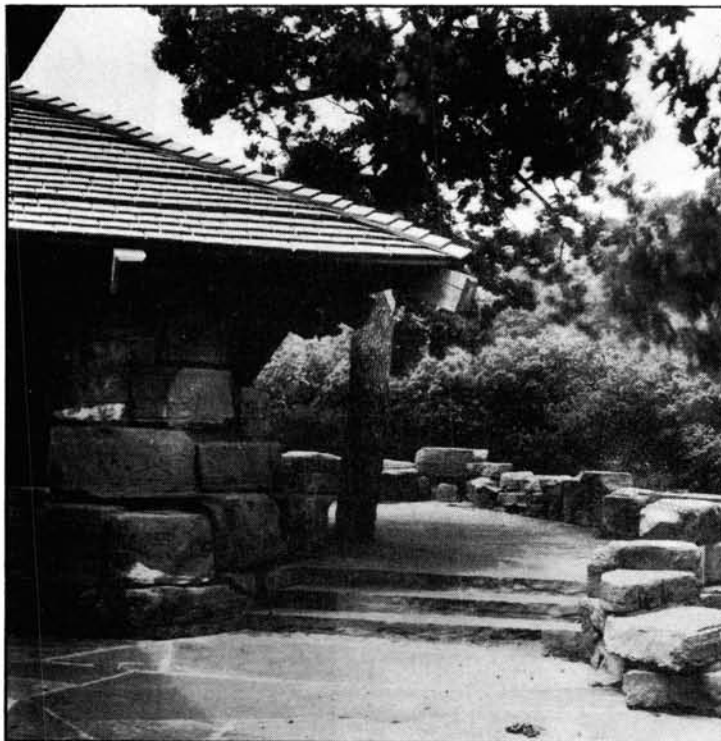

Turner Falls State Park, Oklahoma

Exposed Joints

The mortar joints make up a considerable portion of the wall, and therefore have much to do with the appearance of the wall. They should be studied for the effect of width, color, type, and texture.

Width. With standard brick, two headers require a 1/2-inch joint to make up the length of a stretcher. For all work in bonds and patterns, therefore, the 1/2-inch joint is most practical. A mortar bed thicker than 1/2-inch is difficult to hold in place.

Color. This does not depend upon added colors, for good effect, more than it does upon keeping the mortar of such a degree of whiteness as to make an agreeable contrast or harmony with the brick. For most jobs a white mortar made of clean materials, laid in a pleasing style of joint, will be most satisfactory.

Type. Its greatest effect on the appearance of the finished wall is in the shadow patterns which the joint helps to form. Some of the joints shown in the illustration will catch light most of the time, while others will be dark most of the time. These light and shade effects have as much to do with the appearance of the wall as the color of the mortar joint and the type of bond.

Texture. This is of less importance in mortar joints than width, color, or type. But in some special kinds of work, using textured brick, wide joints, and colored mortar, a texture added to the joint may be of some value.

Types of Joints. The illustration shows seven common joints for exposed surfaces. All of these require special tools except the flush joint, although the weathered and struck joints can also be made with the trowel, and these three are satisfactory for all ordinary work.

Bond

Bond is the arrangement of masonry units so that by their overlapping the entire wall is tied together throughout its length and breadth, and will therefore act as a unit in carrying the load.

In exposed surfaces the bond answers another purpose; the joints being arranged to form attractive geometrical patterns which contribute the chief element of beauty in masonry. There are three basic types, Running Bond, Flemish Bond, and English Bond, and many variations of each. They are distinguished by the manner in which the vertical joint lines are broken.

The illustration shows eight bonds which are commonly employed.

When the bond does not work out between the joints with an even number of brick, a brick is cut to fill the odd space. Door and window jambs should have whole brick, and the bond worked away for some distance before inserting a filler, or cut brick. Great care should be taken to place these fillers or cut brick where they will not destroy the effect of the bond.

BONDS AND JOINTS

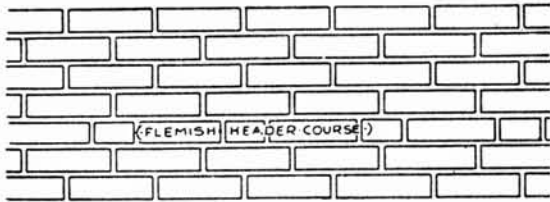

COMMON BOND

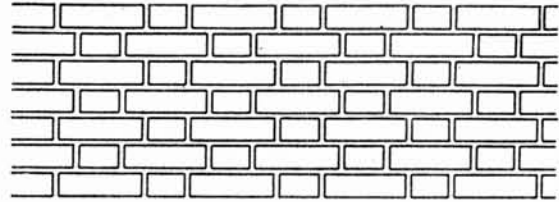

FLEMISH BOND

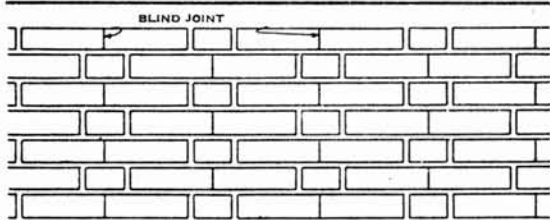

DOUBLE STRETCHER FLEMISH BOND

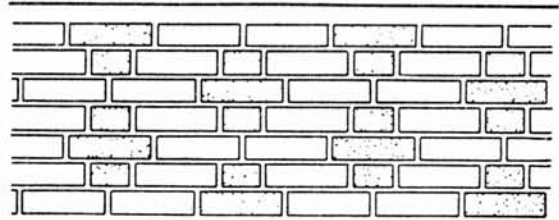

FLEMISH CROSS BOND

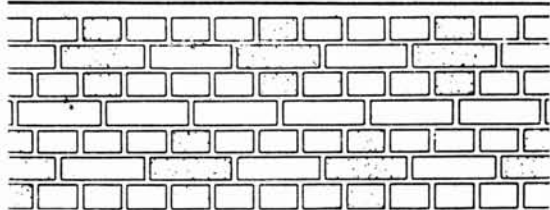

ONE OF MANY METHODS OF EMPHASIZING PATTERN IN ENGLISH CROSS BOND

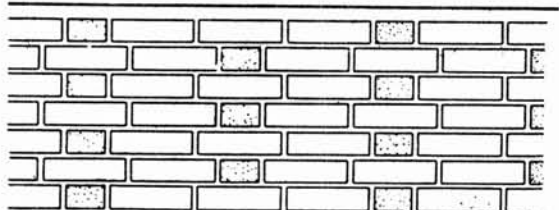

GARDEN WALL BOND

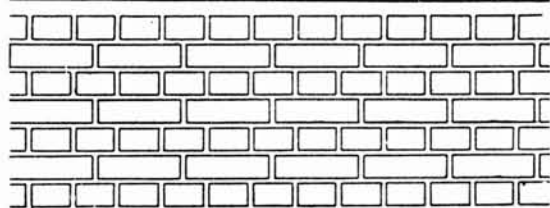

ENGLISH BOND

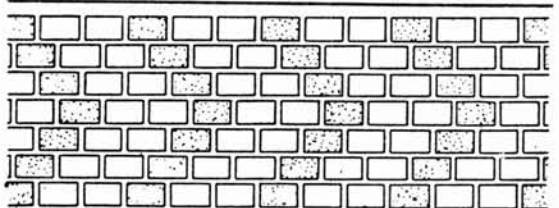

RUNNING HEADER BOND

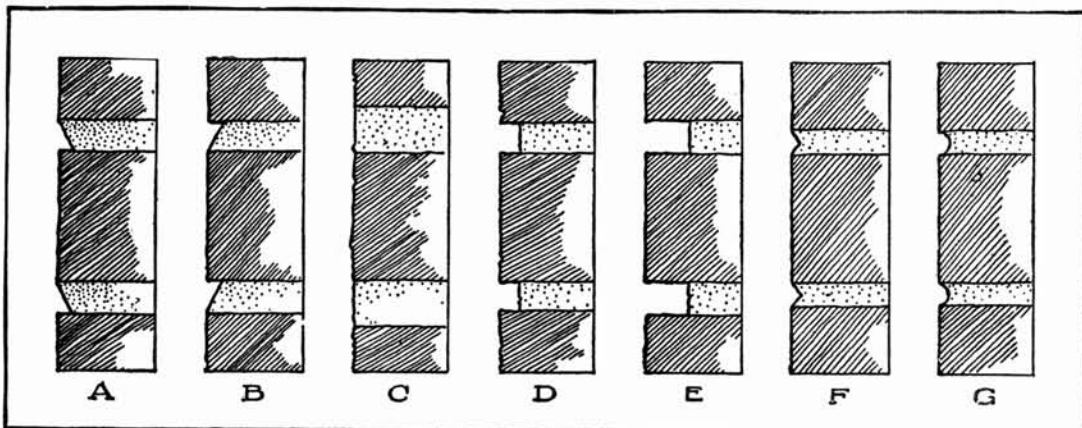

Common types of joints. (a) struck joint, (b) weathered joint, (c) flush or plain cut joint (d) raked joint, (e) stripped joint, (f) "V" joint, (g) concave joint.

TYPES OF STONE MASONRY

Stone masonry is divided into three principal classes:

Rubble Masonry

Rubble, composed of natural stone, or stone so dressed as not to permit laying with uniformly thick joints or horizontal joints.

Rubble masonry may be laid coursed or uncoursed. When coursed the stones are leveled off at specified heights to an approximately horizontal surface. These courses are not necessarily of the same height, but may rise by steps. This work is said to be random coursed. In uncoursed rubble, the stones are fitted together without regard for courses. Dry rubble is laid without mortar, in low retaining walls and slope walls.

Most of the low retaining walls, slope walls, and miscellaneous structures in park projects are laid up in rubble masonry. It fits into the surroundings better than more formal kinds of masonry, and is usually built of stones found nearby. For these projects, it is the most attractive masonry when well built, and satisfies all of the requirements of such field structures.

More than that, rubble masonry is a thing of beauty when well done, and its composition and pattern call for good judgment and imagination. One factor in making a pleasing job is the choice of stones for size. By observing the rule that headers must be used frequently to tie the wall together, considerable variation in size will be realized. Smaller stones, chinking irregular spaces between larger stones, also add to the pattern.

The choice of stones for shape is another factor deserving much study. Since it is unnecessary to hold to courses of uniform height, odd shapes can be used with fine effect. Occasionally a stone of striking shape and considerable size can be placed to break up too much regularity in the pattern. Long, thin planes give a horizontal effect, which is most pleasing in low structures.

The mortar joints must be kept as uniform in thickness as possible. Much variation in the thickness of the joints will destroy whatever beauty the pattern may have in other respects.

Remember that the wall must be strong, as well as pleasing. So there is more than the pattern on the face to consider. The pattern need not be sacrificed for strength, if stones are chosen for their width extending through the wall, as well as for shape and size, and if care is taken to use a header at every opportunity.

GLASSES OF MASONRY

RUBBLE

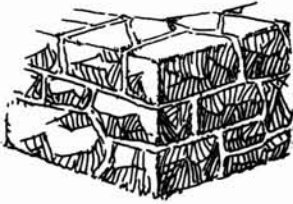

Fig. 1

In uncoursed rubble masonry as shown in Fig. 1, the stones are laid without any attempt to form regular courses.

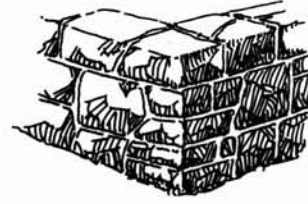

Fig. 2

In coursed rubble masonry as shown in Fig. 2, the stones are leveled off at specified heights to an approximately horizontal surface. These courses are not necessarily of the same height throughout but may rise by steps. In this case the work is said to be random coursed.

SQUARED STONE



Fig. 3

Range Masonry

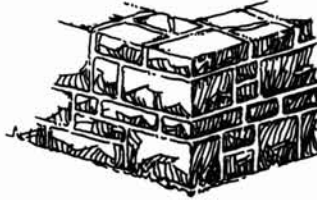

Fig. 4

Broken Range Masonry



Fig. 5

Random Masonry

ASHLAR

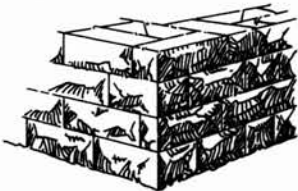

Fig. 6

Ashlar masonry is divided into two classes: (a) Ranged or regular coursed ashlar (Fig. 6), also called cut-stone work or dimensioned-stone work. This consists of rectangular blocks cut and pressed to prescribed dimensions and laid in courses of uniform height or rise.



Fig. 7

This is broken ashlar, formed of rectangular stones cut to dimensions, but the stones are not of equal thickness and they are laid in the wall in courses which are not continuous throughout and which are not necessarily of the same rise.

Rubble masonry is one of the best things that an enrollee can learn to handle, for experts in this trade are in demand, and architects and landscape architects always have need of men who can lay up this type of masonry in an artistic manner.

The thing we find most beautiful is that which satisfies our sense of proportion and of suitability of materials, and our feeling for good taste in design. It will be simple and appropriate, in a pattern pleasing in its variety and balance, and having unity with its surroundings.

Squared Stone Masonry

Squared Stone Masonry is laid up with stone that has been roughly dressed to permit its laying with horizontal joints $1/2$ inch thick or thicker, and is adapted to the same bonds as ashlar. It is not dressed to as fine a finish as ashlar, and therefore may require joints thicker than $1/2$ inch to take up the inequalities of the stones. It is divided into three classes:

Range masonry, in which all stones are of the same height, and their lengths are fairly uniform.

Broken range, in which the courses are not all of the same height, and two stones are occasionally used to make up the height of the course. The length of the stones may vary a great deal.

Random range, in which the height of courses, the height of stones to make up the courses, and the length of stones may all vary, making an irregular pattern not greatly different from broken ashlar.

Ashlar Masonry

Ashlar is stone dressed to permit laying with uniformly thick horizontal joints $1/2$ inch thick or less. It is divided into two classes:

First, ranged or regular coursed ashlar, also called cut-stone work, or dimensioned stone work. This is made of rectangular blocks cut and dressed to prescribed dimensions, and laid in courses of uniform height.

Second, broken ashlar, which is made of rectangular stones cut to dimensions, but not of equal thickness, and laid in the wall in courses which are not continuous throughout. The courses are not always of the same height.

Ashlar is the finest class of masonry. Extreme care is used in setting the stones. The bed for the stone must be thoroughly clean, and wetted down. A thin layer of mortar is then spread evenly. The

bed surface of the stone is wetted down. Then the stone is lowered into place on two strips of wood laid in the mortar. Next, with a pinch bar, the stone is moved into its exact position, and plumbed. The strips of wood are then removed, and the stone settled into place, being leveled by striking with a wooden mallet. The mortar joint should not be over 1/2 inch thick.

Each of these three classes of stone masonry is divided into several others. These other classes and combinations of types are often used with distinctive names.

MORTAR JOINTS

The thickness of mortar joints depends chiefly upon the fineness with which the edges of stones are hewn to lines. Ashlar can take joints of almost any specified or desired thickness because of its finely finished edges. Some stone, such as Indiana limestone, is finished by machines at the quarry for big jobs, and will take very thin joints. Other classes of stone work must take thicker joints as they grade back toward coarser finishes.

VENEERS

Veneer is a thin wall of any mineral building units, such as brick, tile, or stone, erected outside of a frame wall. Its purpose is usually to improve the appearance of the structure, though when well built, it also reduces the radiation of heat, keeps out the wind and moisture, and reduces maintenance costs.

The frame wall is erected first, and then the veneer is laid up, fastening it to the frame wall at frequent intervals with metal ties which are nailed to the studs and laid out into the joints of the masonry. Other devices may be used for the purpose. In point of craftsmanship, veneers cannot be as satisfactory to the mason as solid walls.

GENERAL RULES FOR STONE SETTING

1. Vertical joint lines should be broken at every course.
2. When the thickness of the wall requires two or more pieces of stone, bond stones should run through the wall as often as possible.
3. When the wall is too thick for long bond stones, headers should be used at frequent intervals. They should be placed over the center of stretchers, and extend across two-thirds of the wall thickness, alternately from opposite faces of the wall.
4. When stratified stones are used, they should lie on their natural bed---the bed on which they lay in the quarry.

EXTERIORS



Cook County Forest Preserve District, Illinois



Washington State Park, Missouri

5. Joints should be thin and completely filled with mortar.

6. In warm weather the surfaces of all stones should be wet before being laid in mortar. Porous stones should be wet thoroughly, and at all times, except in freezing weather.

7. Large stones should be used in bottom courses, the thickness of the courses decreasing toward the top of the wall.

8. The rougher the stones are, the thicker the mortar joints will be.

9. Porous stones should not be used below ground, nor should they be used for copings, cornices, window sills, or other places where water can soak into them.

10. If a stone has once been set, and needs to be moved, it should be lifted clear of the mortar. Then the mortar should be scraped off and replaced with a fresh layer.

INTERIORS

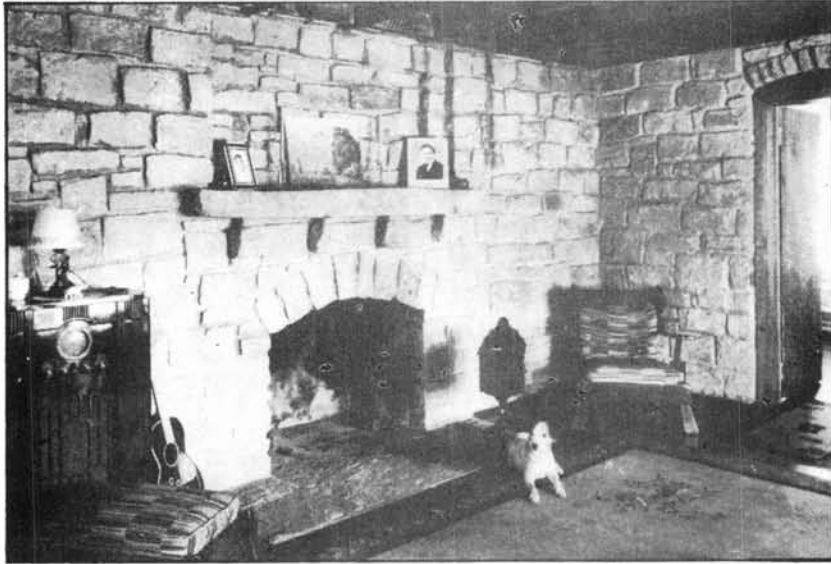

Pine Mountain State Park, Kentucky



Butler Memorial State Park, Kentucky

OUTSIDE STEPS AND WALKS OF BRICK

The following is taken entire from "Brick Structures," published by The Common Brick Manufacturers' Association of America.

Outside Steps. Steps should be laid on a firm base. Treads should never be less than 12 inches wide, or they may be dangerous when covered with ice and snow. Steps should pitch forward with a slope on the tread of about 1/4 inch per foot. The under surface of the concrete base should never slope, but be stepped off horizontally, or the concrete will slide out of place. The concrete should be thick enough to prevent it breaking. It may be reinforced.

Joints in steps should always be filled with cement mortar, and pointed with a "thumb" joint, which is a broad slightly concave joint thoroughly rubbed with a steel jointing tool. The front of the treads should be laid of full length headers. Half bricks should not be used in this position. It is good practice to give the face of the brick to be exposed a coat of raw linseed oil immediately before laying, as this prevents mortar sticking to the face of the brick.

Brick Walks. Brick for this purpose should be hard burned. Walks may be laid in one of two ways, either on sand or cinders or on a concrete base, in the latter case, with mortar or sand joints.

For those who prefer a walk to be a little irregular, perhaps with grass growing up in the joints, the first mentioned method is recommended. Grass can easily be kept down if desired, however, by mixing salt with the sand. To lay a walk in this manner, first, excavate the soil to the depth of about four inches. Lay 1 inch thickness of sand for the border brick, which are placed on edge. Then lay and tamp or roll a 2-inch bed of sand or cinders for the rest of the walk, placing the bricks flat. It is important, especially in a clay soil, to thoroughly drain the sand or cinder bed. If bricks are on edge, the excavation should be proportionately deeper. Leave about 1/2 inch space between the bricks. As soon as they are laid, fill the vertical joints by placing a layer of sand on the walk and sweep it into the joints with a broom. Leave the sand on the walk for a few days, agitating it once or twice a day, so that the joints will be completely filled. Tight mortar joints may be used.

A concrete base will ensure the walk or terrace remaining rigid and even. A lean concrete should be used---3 inches thick---laid on a bed of cinders or sand, thoroughly drained. The brick may be laid on a 1/2-inch setting bed of cement mortar, or upon a bed of sand just thick enough to straighten out the irregularities of the rough concrete. The curb may be formed of concrete or of brick on edge. The vertical joints may be sanded or filled with mortar.

OUTSIDE STEPS AND WALKS

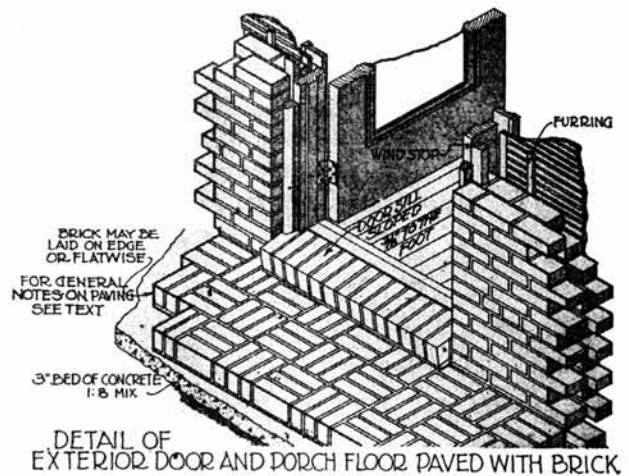
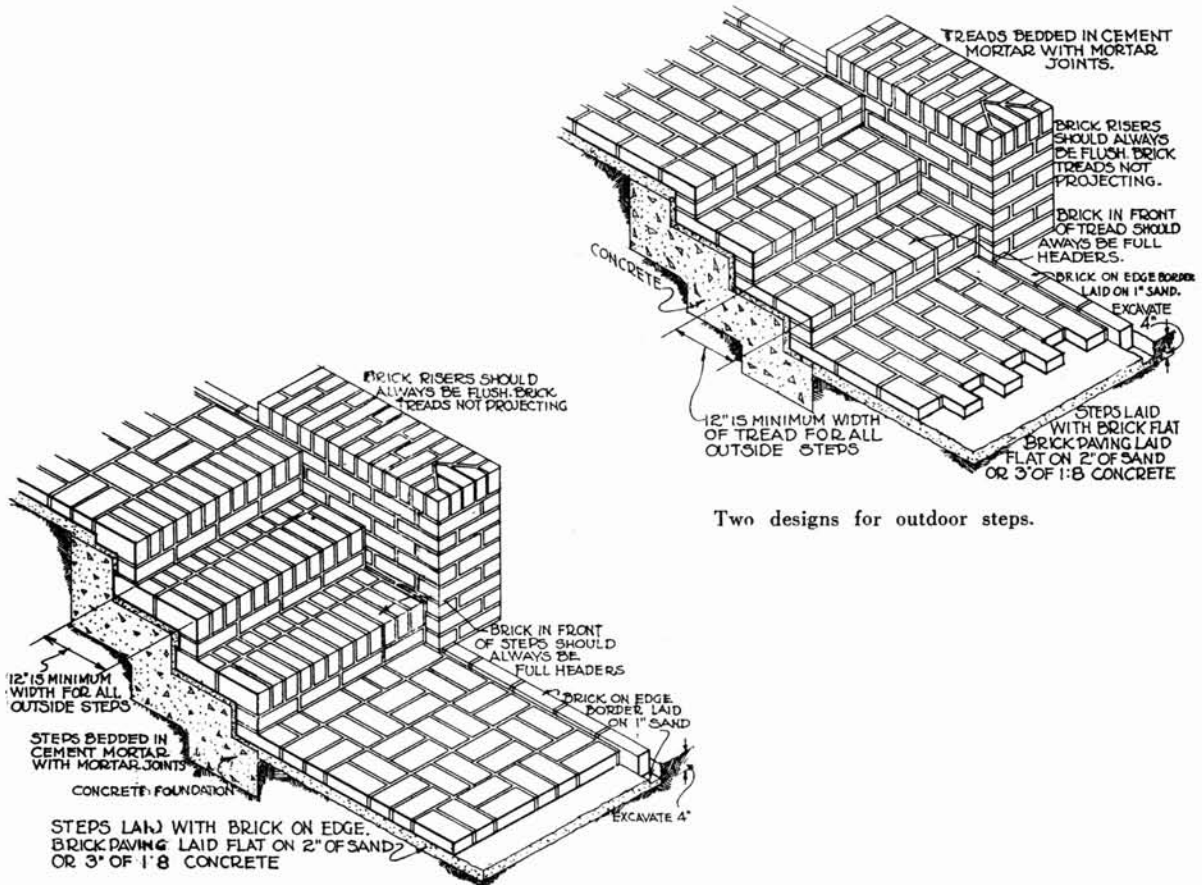

PAVING PATTERNS

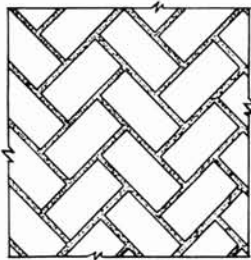

FLAT

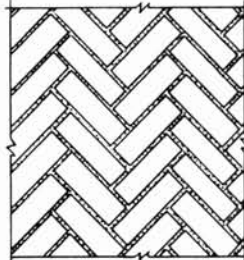

ON EDGE

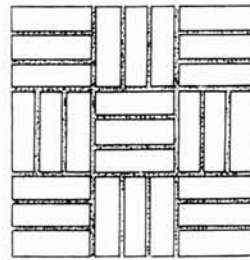

ON EDGE

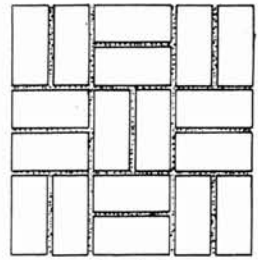

FLAT

HERRING - BONE

BASKET WEAVE

PAVING PATTERNS FOR WALKS & PORCHES

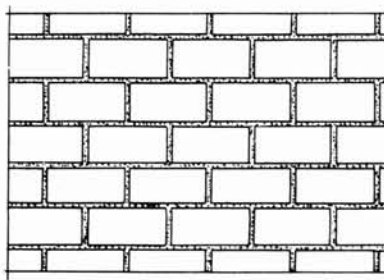

RUNNING

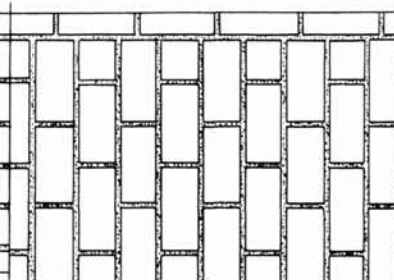

CROSS

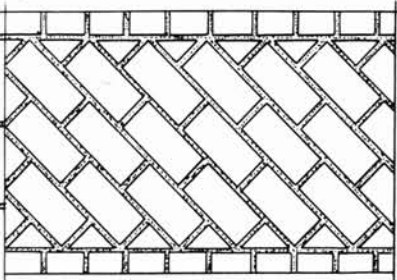

DIAGONAL

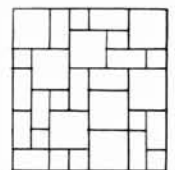
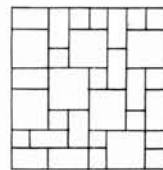
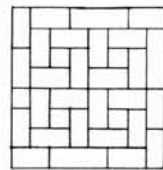
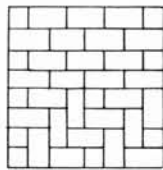
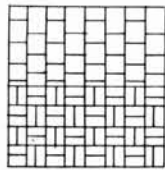
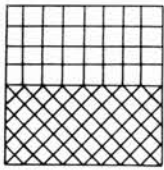

ONE SIZE UNITS

TWO SIZE UNITS

THREE SIZE UNITS

PATTERNS FOR BLUESTONE, SLATE, MARBLE & FLAGGING

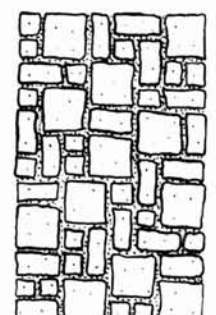
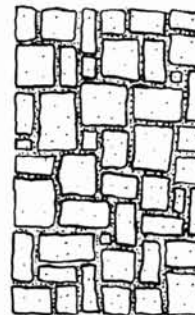
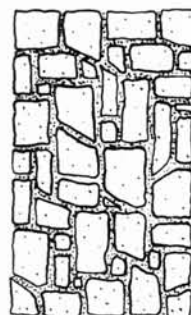
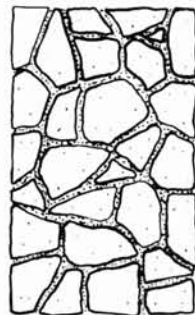
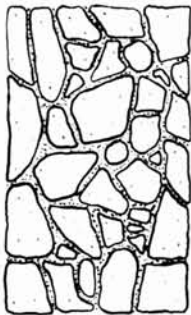

PATTERNS FOR BLUESTONE & SLATE FLAGGING FOR WALKS

In the latter case, the most satisfactory but **the** most expensive method is to carefully trowel the joints. A cheaper way is to broom the joints full of a thin 1/3 cement grout, but this has the disadvantage of smearing the surface of the brick with mortar, which may, however, be removed by going over the surface while the mortar is soft with a scrubbing brush and water containing not more than 5 percent of muriatic acid, afterwards removing the acid by scrubbing again with clean water.

Another and better method is to carefully pour the grout into the joints, the walk should be slightly crowned for drainage if on flat ground. If laid with sand joints on concrete, the latter should have a slight crown.

INTERIORS

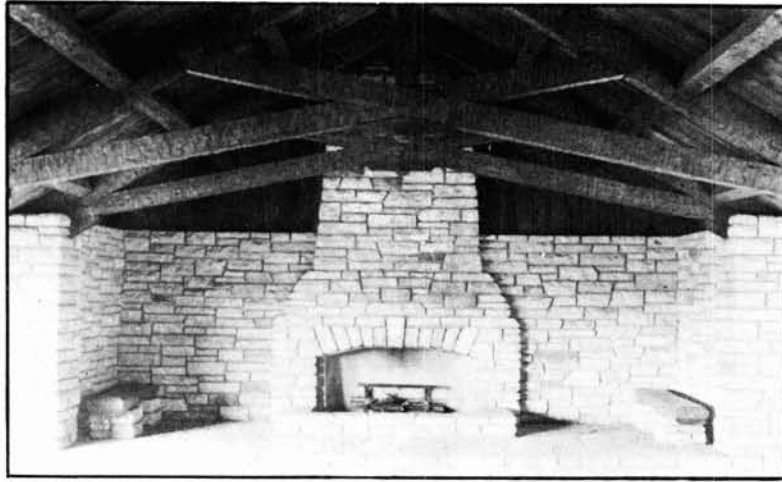

Gook County Forest Preserve District, Illinois



McCormicks Creek State Park, Indiana

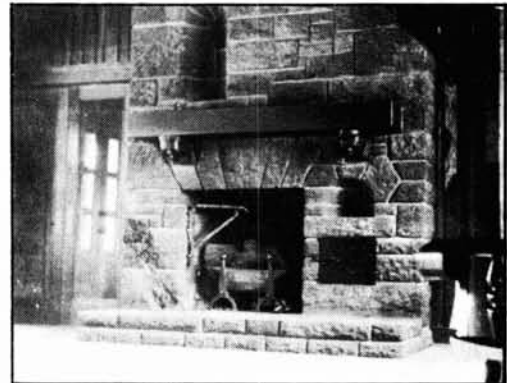

Bastrop-Buescher State Park, Texas

GLOSSARY
OF
TRADE TERMS AND DEFINITIONS

MISCELLANEOUS



Levi Jackson Wilderness Road State Park, Kentucky



Oglebay Metropolitan Park
West Virginia

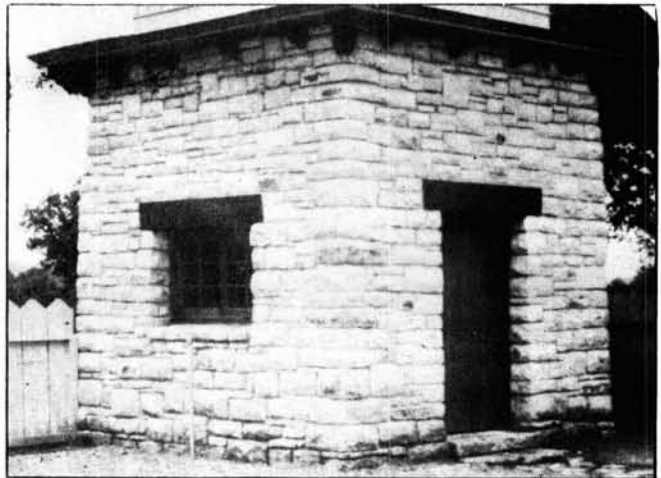

Kerrville State Park, Texas

BRICK AND STONE WORK

Glossary

- BAT:** A part of brick, known as 1/2 bat, or 3/4 bat, according to their length.
- BED JOINT:** The horizontal mortar joint between two courses.
- BOND:** A term applied to the arrangement of units in a wall. The bond ties the wall together by overlapping the units in the different courses, so as to prevent continuous joints.
- BINDERS:** Units that extend from each face of the wall through two-thirds of the thickness of the wall. Bond stones in stone masonry.
- COURSE:** A row of bricks, tile, blocks, or stone between two bed joints. The thickness is the thickness of one brick plus one joint.
- DISCOLORATION:** It may result from three causes:
- Efflorescence: The most common discoloration. The deposit of soluble salts, leached out of brick, stone, and some mortars by rain soaking into the wall, and left on the surface in white blotches.
- Scumming: Discoloration caused during manufacture of bricks.
- Staining: Caused by the deposit of iron rust, soot, and other materials by rain and snow. Yellow, red, and brown stains are leached out of some stones.
- HEADERS:** Brick tile, blocks, or stone laid with their width parallel to the face of the wall. Bond members in brick work.
- LAP:** The horizontal distance between the vertical joints of two successive courses. This must be at least 1/4 of the length of a brick.
- LONGITUDINAL BOND OR "THROUGH" BOND:** The headers extend entirely through the wall.
- PARTS OF A STONE:** Face: The surface exposed to view after laying.
- Back: Opposite the face.
- Bed: Upper and lower surfaces.
- PARTS OF A WALL:** Back: The inner surface.
- Belt or Stringing Courses: Wide or narrow courses projecting from the face of the wall for ornamentation.

MISCELLANEOUS



White Pines Forest State Park, Illinois



Butler Memorial State Park, Kentucky

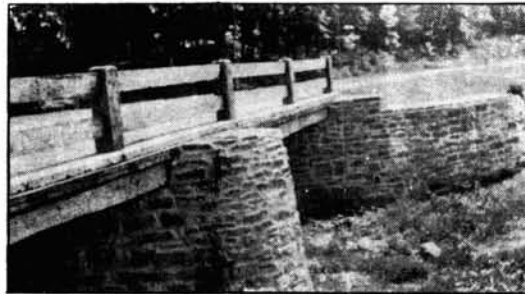

Giant City State Park, Illinois



Bastrop-Buescher State Park, Texas

Blocking Course: A course of large stones on top of the cornice.

Bonding Course: A course composed entirely of bond stones.

Corbel: Composed of units which project from the face of a wall, to support a course projecting still further.

Cornice: Ornamental course on top of the wall.

Coping: The finishing course at the top of the wall, consisting of large stones or concrete units projecting slightly over the wall on both sides, and shaped to drain the water off.

Face: The surface exposed to view.

Footing: Projecting courses at the base.

Header Course: A course composed entirely of headers.

Plinth or Water Table: A projecting course at or near the grade line.

Springing Course: The course from which an arch rises.

Stretching Course: A course composed entirely of stretchers.

- PERPENDS:** The vertical joints in the face of the wall. If they fall immediately over each other in alternate courses, the perpendes are said to be "kept".
- PITCH LINES OR ARRISES:** The four edges of the face when they have been sharply defined with a chisel.
- QUOINS:** The external corners of walls. Sometimes applied to the bricks or stones which form the quoins.
- RISE OR BUILD:** The height between mortar joints. Same as "course," but more generally used for stonework.
- SPALL:** Small pieces of wedge-shaped stone.
- STRETCHERS:** Brick, tile, blocks, or stone laid with their length parallel to the face of the wall.

QUANTITIES OF MATERIALS REQUIRED TO BUILD 100 SQUARE FEET OF WALLCONCRETE BLOCKS

	<u>3$\frac{1}{2}$-in. Course Height</u>	--	<u>12-in. Length</u>	
Wall Thickness (inches)	4		6	8
Units (number)	300		300	300
Mortar (cu. ft.)	5.0		5.5	6.0

	<u>5-in. Course Height</u>	--	<u>12-in. Length</u>	
Wall Thickness (inches)	4		6	8
Units (number)	220		220	220
Mortar (cu. ft.)	5.0		4.0	5.0

	<u>8-in. Course Height</u>	--	<u>16-in. Length</u>	
Wall Thickness (inches)	4		6	8
Units (number)	110		110	110
Mortar (cu. ft.)	3 $\frac{1}{4}$		3 $\frac{1}{4}$	3 $\frac{1}{4}$

----- 0 -----

BRICK

Wall Thickness (inches)	4	8	12	16
Brick (number)	617	1233	1849	2465
Mortar (cu. ft.)	$\frac{1}{2}$ -in. joints assumed	8	20	32
			44	

----- 0 -----

CLAY TILE

<u>End Construction - Cells Vertical - Course Height and Unit Length, 12-in.</u>				
Wall Thickness (inches)	4	6	8	12
Tile (number)	93	93	93	93
Mortar (cu. ft.)	2.5	3.6	4.9	7.3

<u>Side Construction - Cells Horizontal - Length 12-in.</u>				
Size of Unit: (inches)	3-3/4X5X12	8X5X12	8X6 $\frac{1}{2}$ X12	8X10 $\frac{1}{4}$ X12
Wall Thickness (inches)	4	8	8	8
Tile (number)	210	210	171	105
Mortar (cu. ft.)	4.5	9	8	5.25

CONCRETE BLOCKS

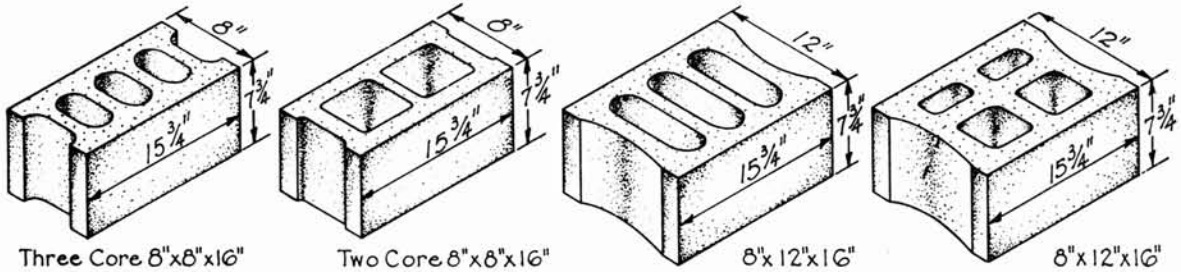

TYPES OF CONCRETE WALL BLOCK - STRETCHERS

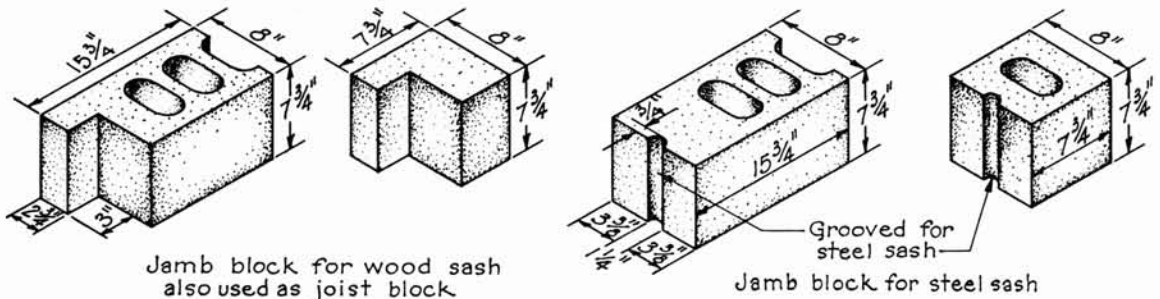
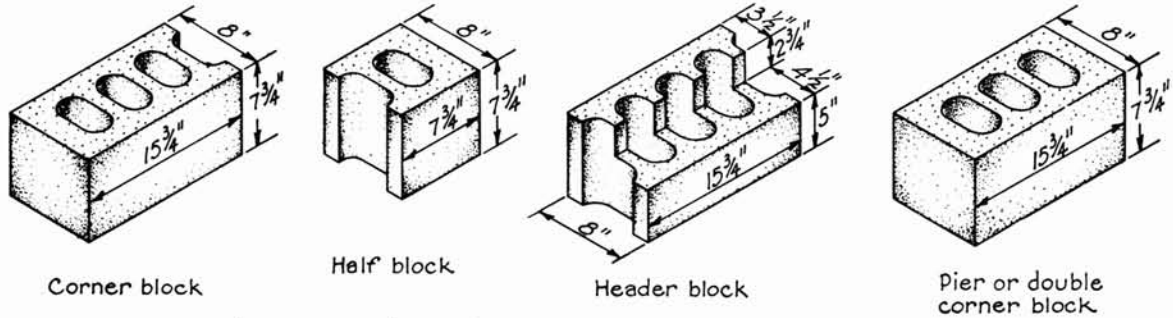

STANDARD SPECIALS FOR 8" BLOCK, ALSO MADE IN THE TWO CORE TYPE SIMILAR SPECIALS ARE REGULARLY FURNISHED FOR 12" BLOCK

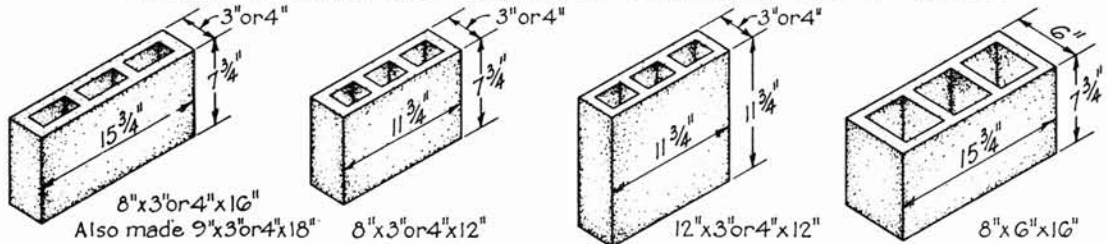

THREE CORE TYPE OF PARTITION BLOCK SIMILAR UNITS ARE OBTAINABLE FOR THE TWO CORE TYPE OR IN SOLID UNITS

CONCRETE BLOCKS

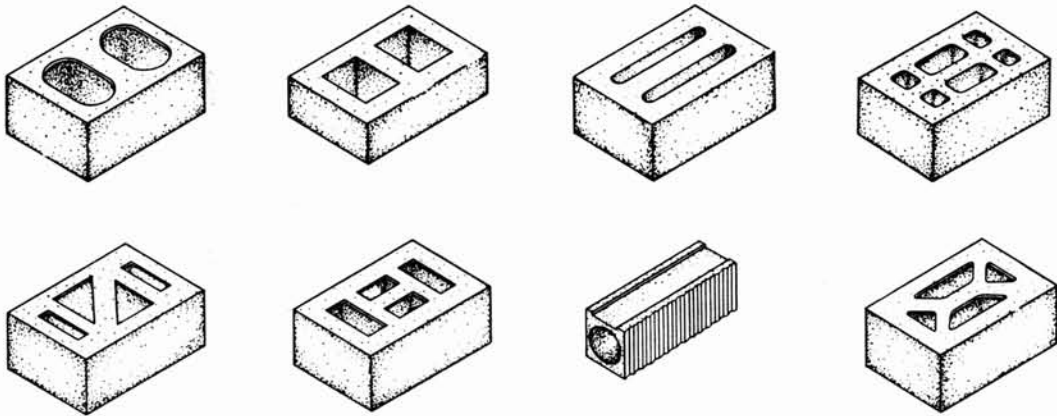

COMMON TYPES OF CONCRETE BUILDING TILE

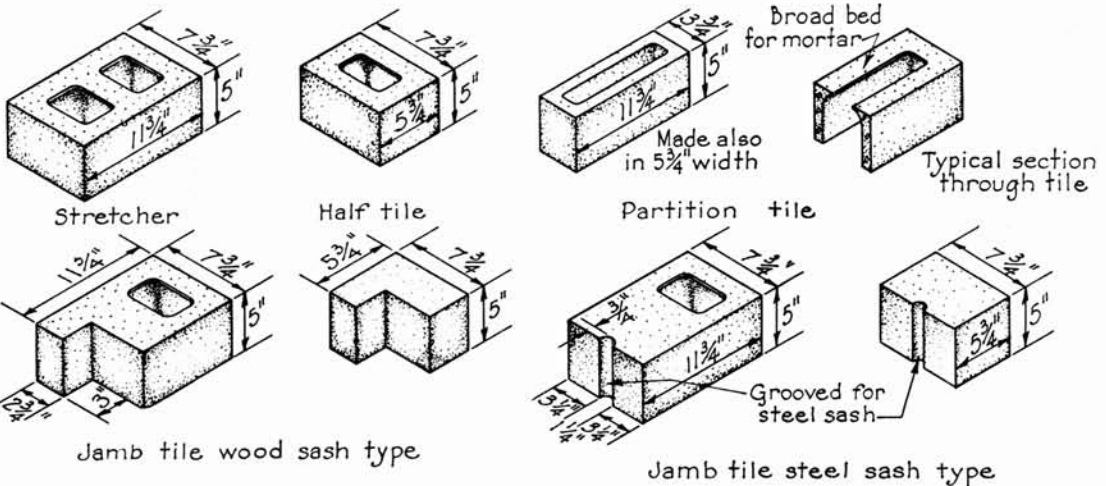

5" x 8" x 12" TILE WITH SPECIALS

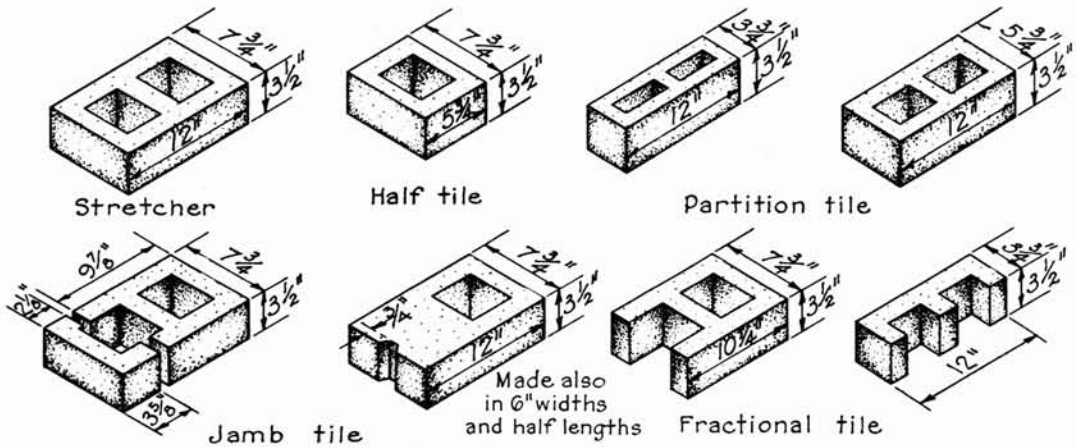

3 1/2" x 8" x 12" TILE WITH SPECIALS